



STATUS[®]



Power tools 2026

CLASSIFICATION

PROFESSIONAL

The dominant line in STATUS power tools range. High efficiency and quality power tools, gearbox housings are made of aluminum or magnesium alloys. Switches and other components possess increased durability. Recommended for construction operations and as a professional tool.

HD PROFESSIONAL

Highly durable and reliable tools built for continuous operation. Recommended for usage by professionals during construction works in severe industry environment.

CONTENTS

- 5** Cordless tools
- 26** Drills
- 27** Rotary hammers
- 30** Angle grinders
- 34** Sanders
- 37** Jig saws
- 38** Routers

SYMBOLS

| | | | | | | | |
|--|--|--|---|--|--|--|---|
| | Two stage reducing gear | | Aluminum alloy gear housing | | Professional cable with the neoprene coating, min. 3 m. long | | Constant electronics |
| | Two speed gearbox | | Magnesium alloy gear housing | | Supplied with carrying case | | Spindle lock function |
| | Drilling | | Safety clutch | | Adjustable pendulum cutting action | | Tool-less wheel guard adjustment function |
| | Drilling Drilling with impact | | SDS-plus accessory mounting system | | Rubber soft grip handle | | 3-position front handle |
| | Drilling Drilling with impact Impact | | SDS-max accessory mounting system | | Keyless chuck | | Rotatable rear handle |
| | Reverse function | | 30 mm hexagonal accessory mounting system | | Keyless metal chuck | | Double insulation |
| | Electronic speed adjustment | | Built-in dust removal system | | Supplied with two 2 battery packs | | Tool-free chaintension function |
| | Soft start | | Cutting line laser marker | | Charge time - 1 hour | | LED working area illumination |



Brushless tools system UniOne 20V

BRUSHLESS



BLDC motor

All **UniOne** system tools are equipped with a brushless motor. The operating principle of a brushless BLDC motor (brushless direct current motor) is to rotate the rotor in an alternating magnetic field, which is created by alternating magnetization of the stator elements. This process is controlled by high-precision electronics. The advantages of the system include:

Energy efficiency

The BLDC motor provides an efficiency gain of more than 30% compared to a brushed motor. This is achieved due to more accurate and efficient operation of the electronics, since the controlled element is the stator electromagnets, not the brushes.

Life time

Since there is no brush wear, no sparking, and no heating of the commutator, a BLDC motor is tens of times more durable than a brush motor.

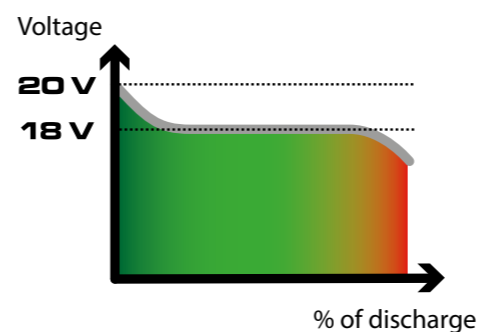

UniOne Li-Ion 20 V

The voltage characteristic of 20 V is the peak value of a fully charged battery.

The nominal (operating) voltage of the **UniOne** battery is 18 V.

Batteries



| Model | ABCTW20-2Li | ABCTW24Li | ABCTW24-2Li |
|----------|-------------|-------------|-------------|
| Voltage | 20 V | 20 V | 20 V |
| Type | Li-Ion | Li-Ion | Li-Ion |
| Capacity | 2 Ah | 4 Ah | 8 Ah |
| Code | 0 77 223 01 | 0 77 222 01 | 0 77 229 01 |

Chargers



| Model | CBCTW24Li | CBCTW24Li-1 |
|-------|-------------|-------------|
| Code | 0 76 121 01 | 0 76 129 01 |

**Cordless drill-driver
CTW24Li**



Features

- | Brushless motor
- | Powerful high torque drill/driver
- | All-metal keyless chuck 13 mm
- | Auxiliary handle
- | Automatic spindle lock
- | Two speed low noise transmission
- | Torque adjustment
- | Built-in illumination of the work area
- | Anti-vibration system on the housing
- | Reverse
- | Speed control
- | Ergonomic rubber grip over
- | Belt clip
- | Hand strap
- | 4 Ah Li-Ion slider battery with charging level indicator
- | STATUS UniOne and LXT Unified Battery System

| | |
|-------------------------|-------------------|
| Voltage | 20 V |
| No load speed | 0-600/0-2100/min. |
| Chuck/holder | Keyless, 13 mm |
| Torque (hard/soft) | 75/50 Nm |
| Torque adjustment steps | 20 + 1 |
| Battery | Li-Ion, 20 V |
| Weight | 1,9 kg |
| Code | 0 71 259 01 |

Set

- | Li-Ion Battery 4 Ah, 1 pcs.
- | Charger
- | Plastic carry case
- | Belt clip
- | Front handle

BRUSHLESS

20v UNI ONE
Lithium-Ion

HD PROFESSIONAL

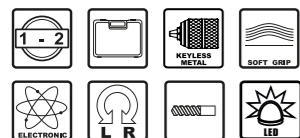

**Cordless drill-driver
CBL20-2Li**



Features

- | Brushless motor
- | All-metal keyless chuck 13 mm
- | Compact design allows use in confined spaces
- | Automatic spindle lock
- | Two speed transmission
- | Clutch torque adjustment
- | Built-in illumination of the work area
- | Reverse
- | Speed control
- | Ergonomic rubber grip over
- | Belt clip
- | Protective strip
- | 2 Ah Li-Ion slider battery with charge level indicator
- | STATUS UniOne and LXT Unified Battery System

| | |
|-------------------------|-------------------|
| Voltage | 20 V |
| No load speed | 0-400/0-1400/min. |
| Chuck/holder | Keyless, 13 mm |
| Torque (hard/soft) | 50/32 Nm |
| Torque adjustment steps | 20 + 1 |
| Battery | Li-Ion, 20 V |
| Weight | 1,3 kg |
| Code | 0 71 261 01 |

Set

- | Li-Ion Battery 2 Ah, 2 pcs.
- | Charger
- | Plastic carry case
- | Belt clip

BRUSHLESS

20v UNI ONE
Lithium-Ion

HD PROFESSIONAL

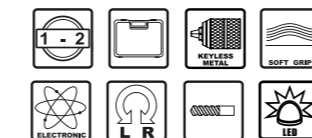

Cordless drill-driver

CBL21Li

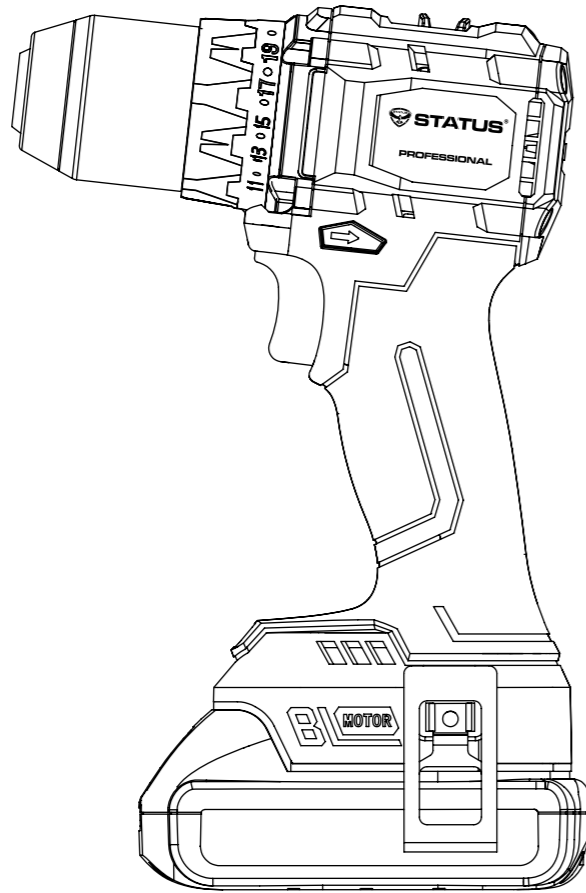

Features

- | Brushless motor
- | All-metal keyless chuck 13 mm
- | Compact design allows use in confined spaces
- | Automatic spindle lock
- | Two speed transmission
- | Clutch torque adjustment
- | Built-in illumination of the work area
- | Reverse
- | Speed control
- | Ergonomic rubber grip over
- | Li-Ion slider battery with charge level indicator
- | Belt clip
- | STATUS UniOne and LXT Unified Battery System

| | |
|-------------------------|-------------------|
| Voltage | 20 V |
| No load speed | 0-460/0-1900/min. |
| Chuck/holder | Keyless, 13 mm |
| Torque (max.) | 60 Nm |
| Torque adjustment steps | 20 + 1 |
| Battery | Li-Ion, 20 V |
| Weight | 0,95 kg |
| Code | 0 71 266 01 |

Set

- | Li-Ion Battery 2 Ah, 1 pcs.
- | Li-Ion Battery 4 Ah, 1 pcs.
- | Charger
- | Plastic carry case
- | Belt clip

BRUSHLESS

20v Lithium-Ion **UNI ONE**

HD PROFESSIONAL

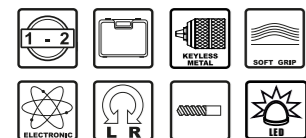

Cordless impact wrench

CTW24HLi



Features

- | Brushless motor
- | High torque
- | Impact function for working with large diameter fasteners
- | Reversible function with two operating modes: continuous and short rotation
- | Aluminium alloy transmission housing
- | Two maximum speed modes
- | Speed control
- | Built-in illumination of the work area
- | 1/2" square bore drive for use with impact sockets and friction ring
- | Ergonomic rubber grip over
- | 4 Ah Li-Ion slider battery with charge level indicator
- | STATUS UniOne and LXT Unified Battery System

| | |
|-----------------------|---------------------|
| Voltage | 20 V |
| No load speed (max.) | I:1000/II:2000/min. |
| Impact rate(max.) | 3000/min. |
| Torque (max.) | 280 Nm |
| Battery | Li-Ion, 20 V |
| Chuck/holder | square 1/2" |
| Weight | 1,9 kg |
| Code | 0 74 104 01 |

Set

- | Li-Ion Battery 4 Ah, 1 pcs.
- | Charger
- | Plastic carry case
- | Impact socket, 22 mm
- | Protective strip

BRUSHLESS

20v Lithium-Ion **UNI ONE**

HD PROFESSIONAL

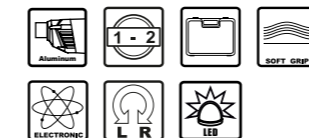

Cordless rotary hammer SDS+ MPB20



Features

- | Brushless motor
- | 3-position operating mode switch
- | SDS+ accessory mounting system
- | Reverse
- | Built-in illumination of the work area
- | Auxiliary handle
- | Ergonomic rubber grip over
- | 4 Ah Li-Ion slider battery with charging level indicator
- | STATUS UniOne and LXT Unified Battery System

| | |
|--------------------|--------------|
| Voltage | 20 V |
| No load speed | 0-1400/min. |
| Impact rate(max.) | 4500/min. |
| Impact energy | 1,7 J |
| Battery | Li-Ion, 20 V |
| Weight | 2,65 kg |
| Code | 0 14 101 01 |

Set

- | Li-Ion Battery 4 Ah, 1 pcs.
- | Charger
- | Plastic carry case
- | Auxiliary handle
- | Depth gauge



BRUSHLESS

20v UNI ONE
Lithium-Ion

HD PROFESSIONAL



Cordless trimmer RH750BL



Features

- | Brushless motor
- | Safety switch with lock-on feature
- | Soft start
- | Electronic speed control
- | Constant speed under load
- | Spindle lock for quick bit changes
- | Routing depth adjustment
- | Removable cast aluminum base
- | Usable with plunge or tilt base
- | Rip fence and roller fence included
- | Dust extraction port included
- | 4 Ah Li-Ion slider battery with charging level indicator
- | STATUS UniOne and LXT Unified Battery System

| | |
|-----------------------|------------------|
| Voltage | 20 V |
| Height | 226 mm |
| No load speed | 10000-30000/min. |
| Cutter Shank Diameter | Ø6, Ø8 mm |
| Battery | Li-Ion, 20 V |
| Weight | 2 kg |
| Code | 0 51 511 01 |

Set

- | Li-Ion Battery 4 Ah, 1 pcs.
- | Charger
- | Rip fence
- | Roller fence
- | Dust extraction port
- | 6 mm collet
- | 8 mm collet
- | Wrench
- | Plastic carry case



BRUSHLESS

20v UNI ONE
Lithium-Ion

PROFESSIONAL



Cordless angle grinder

SH125E



Features

- Brushless motor
- Two rotation speed modes: low and high
- Keeping constant speed in low speed mode
- Soft start
- Auxiliary handle
- Spindle lock
- Aluminium transmission
- 3-position front handle
- Ergonomic rubber grip over
- 4 Ah Li-Ion slider battery with charging level indicator
- STATUS UniOne and LXT Unified Battery System

| | |
|----------------|----------------|
| Voltage | 20 V |
| No load speed | 1000/7500/min. |
| Spindle thread | M14 |
| Blade size | 125 mm |
| Battery | Li-Ion, 20 V |
| Weight | 2,3 kg |
| Code | 0 30 529 01 |

Set

- Li-Ion Battery 4 Ah, 1 pcs.
- Charger
- Plastic carry case
- Auxiliary handle

BRUSHLESS

20v **UNI ONE**
Lithium-Ion

HD PROFESSIONAL



Cordless circular saw

CP165HD*(only body without battery and charger)*

Features

- Brushless motor
- Spindle lock button
- Accidental start protection
- Cutting capacity adjustment (0-52 mm)
- Cutting angle adjustment (0-45°)
- Ergonomic rubber grip over
- 4 Ah Li-Ion slider battery with charging level indicator
- STATUS UniOne and LXT Unified Battery System

| | |
|------------------------|--------------|
| Voltage | 20 V |
| No load speed | 4700/min. |
| Cutting capacity (90°) | 52 mm |
| Blade size outer | 165 mm |
| Blade size inner | 20 mm |
| Battery (not included) | Li-Ion, 20 V |
| Weight | 2,5 kg |
| Code | 0 74 119 01 |

Set

- Guide fence
- Cutting blade
- Dust outlet
- Wrench

BRUSHLESS**20v** UNI ONE
Lithium-Ion**HD** PROFESSIONAL

Cordless circular saw

CP125

Features

- Brushless motor
- Spindle lock button
- Accidental start protection
- Cutting capacity adjustment (0-41 mm)
- Cutting angle adjustment (0-45°)
- Capable of using 20 mm and 22.2 mm bore discs
- Ergonomic rubber grip over
- 4 Ah Li-Ion slider battery with charging level indicator
- STATUS UniOne and LXT Unified Battery System

| | |
|------------------------|----------------|
| Voltage | 20 V |
| No load speed | 7000/min. |
| Cutting capacity (90°) | 41 mm |
| Blade size outer | 120 mm; 125 mm |
| Blade size inner | 20 mm; 22,2 mm |
| Battery | Li-Ion, 20 V |
| Weight | 2,4 kg |
| Code | 0 74 105 01 |

Set

- Li-Ion Battery 4 Ah, 1 pcs.
- Charger
- Guide fence
- Cutting blade 120x20 mm
- Flange 22,2 mm
- Wrench

BRUSHLESS**20v** UNI ONE
Lithium-Ion**HD** PROFESSIONAL

Cordless jig saw

JS800BL**Features**

- Brushless motor
- Quick saw blade change system
- Electronic dual stroke rate control
- Four-position pendulum mode switch
- Cutting area airflow with switch-off option
- Cast aluminum soleplate
- Switch lock-on position
- Non-slip rubberized handle
- Plastic soleplate
- 2 Ah Li-Ion slider battery with charging level indicator
- STATUS UniOne and LXT Unified Battery System

| | |
|-----------------------|---------------|
| Voltage | 20 V |
| No load speed | 800-3500/min. |
| Max. cutting capacity | |
| - wood | 100 mm |
| - metal | 10 mm |
| Stroke length | 23 mm |
| Battery | Li-Ion, 20 V |
| Weight | 1,9 kg |
| Code | 0 74 121 02 |

Set

- Li-Ion Battery 2 Ah, 1 pcs.
- Charger
- Parallel fence
- Wrench
- Vacuum cleaner connection
- Plastic soleplate
- Anti-splinter plate
- Plastic carry case

**BRUSHLESS**
20v **UNI ONE**
 Lithium-Ion
HD PROFESSIONAL

Cordless reciprocating saw

RS800BL**Features**

- Long-lasting brushless motor
- Quick saw blade change systems
- Rubber-coated front and rear handles
- Pendulum mode switch
- Front stop adjustable in steps
- On/off switch with a safety lock to prevent accidental operation
- Dual stroke frequency adjustable by pressing the switch button
- Hanging storage bracket
- 4 Ah Li-Ion slider battery with charging level indicator
- STATUS UniOne and LXT Unified Battery System

| | |
|-----------------------|--------------|
| Voltage | 20 V |
| No load speed | 0-3000/min. |
| Stroke length | 29 mm |
| Max. cutting capacity | |
| - wood | 200 mm |
| - metal | 60 mm |
| Battery | Li-Ion, 20 V |
| Weight | 2,7 kg |
| Code | 0 74 120 02 |

Set

- Li-Ion Battery 4 Ah, 1 pcs.
- Charger
- Saw blade

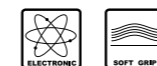
BRUSHLESS
20v **UNI ONE**
 Lithium-Ion
HD PROFESSIONAL

Cordless grass trimmer DB20CB-20 Kit



Features

- Brushless motor
- Two speed settings: for line and for blade
- Under-mounted motor (no flexible drive)
- Battery level indicator
- Shock-resistant protective shield
- Safety strap
- Folding design
- Adjustable intermediate handle
- 4 Ah Li-Ion slider battery with charging level indicator
- STATUS UniOne and LXT Unified Battery System

| | |
|----------------|--------------|
| Voltage | 20 V |
| No load speed | |
| - line | 5500/min. |
| - blade | 7500/min. |
| Cutting width | |
| - line | 330 mm |
| - blade | 250 mm |
| Line thickness | 1,6 mm |
| Battery | Li-Ion, 20 V |
| Weight | 3,8 kg |
| Code | 0 74 112 02 |

Set

- Li-Ion Battery 4 Ah, 1 pcs.
- Charger
- Spool of line
- Knife
- Screws
- Wrench
- Belt



BRUSHLESS

20v Lithium-Ion **UNI ONE**

GARDEN

Cordless chain saw SCB300-20 Kit



Features

- Brushless motor
- Accidental start protection
- Safety guard with instant brake activation
- Automatic chain lubrication
- Tool-free chain tensioning
- Ergonomic rubberized handle provides a perfect grip
- 4 Ah Li-Ion slider battery with charging level indicator
- STATUS UniOne and LXT Unified Battery System

| | |
|-----------------------|--------------|
| Voltage | 20 V |
| Rotation Speed | 3500/min. |
| Chain Speed (Max.) | 10 m/s² |
| Bar Length | 300 mm (12") |
| Chain Pitch | 3/8" |
| Number of Chain Links | 45 |
| Groove Width | 1,3 mm |
| Battery | Li-Ion, 20 V |
| Weight | 4 kg |
| Code | 0 74 108 02 |

Set

- Li-Ion Battery 4 Ah, 1 pcs.
- Charger
- Bar
- Chain
- Safety hood



BRUSHLESS

20v Lithium-Ion **UNI ONE**

GARDEN

Cordless chain saw

SCB250-20 Kit**Features**

- Brushless motor
- Accidental start protection
- Safety guard with instant brake activation
- Automatic chain lubrication
- Tool-free chain tensioning
- Ergonomic rubberized handle provides a perfect grip
- 4 Ah Li-Ion slider battery with charging level indicator
- STATUS UniOne and LXT Unified Battery System

| | |
|-----------------------|--------------|
| Voltage | 20 V |
| Rotation Speed | 3700/min. |
| Chain Speed (Max.) | 10 m/s |
| Bar Length | 250 mm (10") |
| Chain Pitch | 3/8" |
| Number of Chain Links | 40 |
| Groove Width | 1,1 mm |
| Battery | Li-Ion, 20 V |
| Weight | 2,8 kg |
| Code | 0 74 118 02 |

Set

- Li-Ion Battery 4 Ah, 1 pcs.
- Charger
- Bar
- Chain
- Safety hood





Cordless chain saw

SCB201-20*(only body without battery and charger)***Features**

- Brushless motor
- Keyless chain tension adjustment
- Safety hilt on the front handle
- Automatic chain lubrication
- Accidental start protection
- Ergonomic rubberized handle
- STATUS UniOne and LXT Unified Battery System

| | |
|------------------------|--------------|
| Voltage | 20 V |
| Rotation Speed | 4600/min. |
| Chain Speed (Max.) | 8 m/s |
| Bar Length | 200 mm (8") |
| Chain Pitch | 1/4" |
| Number of Chain Links | 45 |
| Groove Width | 1,1 mm |
| Battery (not included) | Li-Ion, 20 V |
| Weight | 1,4 kg |
| Code | 0 74 117 01 |

Set

- Bar
- Chain
- Safety hood





Cordless drill-driver

CBL16-2Li



Features

- Brushless motor
- All-metal keyless chuck 13 mm
- Compact design allows use in confined spaces
- Automatic spindle lock
- Two speed low noise transmission
- Clutch torque limit adjustment
- Built-in illumination of the work area
- Reverse
- Speed adjustment by pressing the start switch
- Ergonomic handle with rubber provides perfect grip over
- Compact 2 Ah Li-Ion battery
- Charge level indicator

| | |
|-------------------------|--------------------|
| Voltage | 16 V |
| No load speed | 0-400/0-1400/min. |
| Chuck/holder | Keyless, 13 mm |
| Torque (hard/soft) | 45/30 Nm |
| Torque adjustment steps | 20 + 1 |
| Battery | Li-Ion, 16 V, 2 Ah |
| Weight | 1 kg |
| Code | 0 71 260 01 |

Set

- Li-Ion Battery 2 Ah, 2 pcs.
- Charger
- Plastic carry case

2 Ah BRUSHLESS

HD PROFESSIONAL

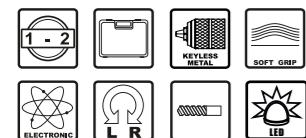

Cordless chain saw

CP115



Features

- Brushless motor
- Suitable for trimming trees
- Accidental start protection
- Removable protective cover
- Ergonomic handle with rubber provides perfect grip over
- Compact 2 Ah Li-Ion battery
- Charge level indicator

| | |
|-----------------------|--------------------|
| Voltage | 16 V |
| No load speed | 4600/min. |
| Chain speed (max.) | 6,7 m/s |
| Bar length | 100 mm |
| Chain pitch | 1/4" |
| Number of chain links | 28 |
| Battery | Li-Ion, 16 V, 2 Ah |
| Weight | 1,2 kg |
| Code | 0 74 106 01 |

Set

- Li-Ion Battery 2 Ah, 2 pcs.
- Charger
- Bar
- Chain
- Safety hood

2 Ah BRUSHLESS

HD PROFESSIONAL

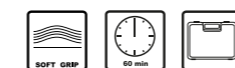

Cordless drill-driver

CBL12Li / CBL12-2Li



* only for CBL12-2Li



Features

- Brushless motor
- Single sleeve chuck 10 mm
- Compact design allows use in confined spaces
- Automatic spindle lock
- Two speed low noise transmission
- Clutch torque limit adjustment
- Built-in illumination of the work area
- Reverse
- Speed adjustment by pressing the start switch
- Ergonomic handle with rubber provides perfect grip over
- Compact 2 Ah Li-Ion battery
- Charge level indicator

| | CBL12Li | CBL12-2Li |
|-------------------------|--------------------|--------------------|
| Voltage | 12 V | 12 V |
| No load speed | 0-400/0-1400/min. | 0-400/0-1400/min. |
| Chuck/holder | Keyless, 10 mm | Keyless, 10 mm |
| Torque (hard/soft) | 38/24 Nm | 38/24 Nm |
| Torque adjustment steps | 20 + 1 | 20 + 1 |
| Battery | Li-Ion, 12 V, 2 Ah | Li-Ion, 12 V, 2 Ah |
| Weight | 1 kg | 1 kg |
| Code | 0 71 263 01 | 0 71 264 01 |

BRUSHLESS

PROFESSIONAL 2 Ah



Set

- Li-Ion Battery 2 Ah, 1 pcs.
- Charger



Set

- Li-Ion Battery 2 Ah, 2 pcs.
- Charger
- Plastic case



Cordless angle grinder

SH115E



Features

- Brushless motor
- Compact design for working in limited spaces
- The ergonomic rubberized handle ensures a perfect grip
- Compact 2 Ah lithium-ion battery
- Spindle lock function

| | |
|----------------|--------------------|
| Voltage | 12 V |
| No load speed | 20000 /min. |
| Spindle thread | M10 |
| Blade size | 75-76 mm |
| Battery | Li-Ion, 12 V, 2 Ah |
| Charging time | 60 min. |
| Weight | 0,65 kg |
| Code | 0 74 107 01 |

Set

- Li-Ion Battery 2 Ah, 1 pcs.
- Charger
- Cutting blade, 3 pcs.

BRUSHLESS

PROFESSIONAL 2 Ah

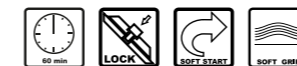

Impact drill DP950



DP950

| | |
|------------------------|-------------|
| Voltage | 220-240 V~ |
| Input power | 950 W |
| No load speed | 0-3000/min. |
| Chuck/holder | key, 13 mm |
| Drilling capacity max. | |
| - wood | 25 mm |
| - steel | 10 mm |
| - concrete | 13 mm |
| Weight | 2,4 kg |
| Code | 0 21 427 01 |

Set

- Auxilliary handle
- Depth gauge
- Plastic case



Rotary hammer SDS-max MPR70



| | |
|-------------------|--------------|
| Voltage | 220-240 V~ |
| Input power | 1200 W |
| No load speed | 300-600/min. |
| Max. Impact rate | 3500/min. |
| Impact energy | 10 J |
| Holder type | SDS-max |
| Drilling capacity | |
| - drill bit | 42 mm |
| - core bit | 85 mm |
| Weight | 7,1 kg |
| Code | 0 11 702 01 |

Set

- Auxilliary handle
- Depth gauge
- Drill bit
- Plastic carry case

HD PROFESSIONAL

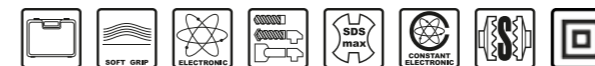

Brushless rotary hammer SDS+

MPR50BL



*Activates and shuts off the motor when jamming is detected, i.e., a sudden change in the drill's position relative to the drilling axis

| | |
|-------------------|-------------|
| Voltage | 220-240 V~ |
| Input power | 1260 W |
| No load speed | 1100/min. |
| Impact rate | 5300/min. |
| Impact energy | 7 J |
| Drilling capacity | |
| - drill bit | 32 mm |
| - core bit | 90 mm |
| Cable length | 4 m |
| Weight | 5,8 kg |
| Order code | 0 12 814 01 |

Set

- Plastic case
- Wrench

BRUSHLESS

HD PROFESSIONAL



Rotary hammer SDS+

MPR26



| | |
|--------------------|-------------|
| Voltage | 220-240 V~ |
| Input power | 800 W |
| No load speed | 0-1350/min. |
| Impact rate (max.) | 5300/min. |
| Impact energy | 3 J |
| Drilling capacity | |
| - drill bit | 26 mm |
| - core bit | 68 mm |
| Cable length | 3 m |
| Weight | 2,8 kg |
| Order code | 0 12 813 01 |

Set

- Plastic case
- Drill bit set (6, 8, and 10 mm)
- Pick
- Chisel
- Additional handle
- Drilling depth gauge
- Spare brush set

PROFESSIONAL



Brushless angle grinder

SA230BL



| | |
|----------------|-------------|
| Voltage | 220-240 V~ |
| Power | 2800 W |
| Rotation Speed | 6500/min. |
| Spindle Thread | M14 |
| Disc Diameter | 230 mm |
| Weight | 5,75 kg |
| Cable Length | 4 m |
| Code | 0 30 532 01 |

Set

- Front handle
- Wrench
- Protective cover

BRUSHLESS

HD PROFESSIONAL



Brushless angle grinder

SA125BLE



| | |
|----------------|-----------------|
| Voltage | 220-240 V~ |
| Power | 1300 W |
| Rotation Speed | 2880-11000/min. |
| Spindle Thread | M14 |
| Disc Diameter | 125 mm |
| Weight | 1,3 kg |
| Cable Length | 3 m |
| Code | 0 30 530 01 |

Set

- Front handle
- Wrench
- Protective cover

BRUSHLESS

HD PROFESSIONAL



Angle grinder SH1251CSE



| | |
|----------------|-----------------|
| Voltage | 220-240 V~ |
| Power | 1500 W |
| Rotation Speed | 4000-11000/min. |
| Spindle Thread | M14 |
| Disc Diameter | 125 mm |
| Weight | 2.7 kg |
| Cable Length | 3 m |
| Code | 0 30 531 01 |

Set

- Front handle
- key
- protective cover

HD PROFESSIONAL



Angle grinder SH1252SE



| | |
|----------------|-----------------|
| Voltage | 220-240 V~ |
| Power | 1200 W |
| Rotation Speed | 4000-11000/min. |
| Spindle Thread | M14 |
| Disc Diameter | 125 mm |
| Weight | 2.7 kg |
| Cable Length | 3 m |
| Code | 0 30 533 01 |

Set

- Front handle
- key
- protective cover

PROFESSIONAL



Multi-purpose sander XS2-125



| | |
|---------------|------------------|
| Voltage | 220-240 V~ |
| Input power | 220 W |
| No load speed | 14000-24000/min. |
| Orbit | 1,8 mm |
| Weight | 1,4 kg |
| Code | 0 36 107 01 |

Set

- Sanding pads, 4 pcs
- Dust container, 1 pcs
- Sandpaper

PROFESSIONAL



Orbital sander XS3-125ET



| | |
|---------------|-----------------|
| Voltage | 220-240 V~ |
| Input power | 450 W |
| No load speed | 4000-13500/min. |
| Orbit | 5 mm |
| Pad size | Ø125 mm |
| Weight | 2,1 kg |
| Code | 0 36 108 01 |

Set

- Dust collector
- Sheet of sandpaper

PROFESSIONAL



Orbital sander XS2-125ET



| | |
|------------------|------------------|
| Voltage | 220-240 V |
| Input power | 300 W |
| No load speed | 5000-12000/min. |
| Oscillation rate | 10000-24000/min. |
| Pad size | Ø125 mm |
| Weight | 1,4 kg |
| Code | 0 36 104 01 |

Set

- Dust container, 1 pcs.
- Sandpaper

PROFESSIONAL



Jig saw JS801



| | |
|--------------------|-------------|
| Voltage | 220-240 V~ |
| Power | 750 W |
| Stroke Rate | 0-3000/min. |
| Max. Cutting Depth | |
| - Wood | 120 mm |
| - Steel | 8 mm |
| Stroke Length | 26 mm |
| Weight | 2,9 kg |
| Code | 0 41 912 01 |

Set

- Parallel fence
- Key
- Vacuum cleaner connection
- Plastic soleplate
- Anti-splinter plate

PROFESSIONAL



Router

RH1400CE

Electronic speed control with LCD display



| | |
|-----------------------|------------------|
| Voltage | 220-240 V~ |
| Power | 1400 W |
| Rotation speed | 12000-28000/min. |
| Cutter shank diameter | Ø8, Ø12 mm |
| Milling depth | 55 mm |
| Weight | 3,6 kg |
| Order code | 0 51 513 01 |

Set

- ▮ Rip fence
- ▮ Dust extraction nozzle
- ▮ 12 mm collet
- ▮ 8 mm bushing
- ▮ Copying bushing
- ▮ Wrench

PROFESSIONAL



Trimmer

RH751

Features

- ▮ Soft start
- ▮ Electronic speed control with LCD display
- ▮ Maintains constant speed under load
- ▮ Spindle lock for quick cutter changes
- ▮ Routing depth adjustment
- ▮ Removable cast aluminum alloy base
- ▮ Safety switch with lock-on function
- ▮ Usable with plunge or tilt base
- ▮ Rip fence and roller fence included
- ▮ Dust extraction pipe included
- ▮ Removable brush covers

| | |
|-----------------------|------------------|
| Voltage | 220-240 V~ |
| Power | 750 W |
| Rotation speed | 13000-33000/min. |
| Cutter shank diameter | Ø6, Ø8 mm |
| Weight | 1,9 kg |
| Code | 0 51 512 01 |

Set

- ▮ Rip fence
- ▮ Roller fence
- ▮ Dust extraction port
- ▮ 6 mm collet
- ▮ 8 mm collet
- ▮ Additional detachable handles
- ▮ Wrench

PROFESSIONAL



Additional bases for trimmers RH750BL and RH751

Plunge base



Code 0 52 605 01

Tilt base



Code 0 52 606 01



STATUS®

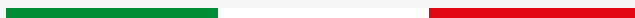

STATUS Italia s.r.l.

Via Aldo Moro, Nr. 14/A

IT36060 - Pianezze

Zona industriale, (VI), ITALY

e-mail: office@status-tools.eu

sales@status-tools.com